



Flodis

Single jet turbine type water meter

Flodis is single jet turbine type meter, designed to measure cold drinking water, offering the capability to measure accurately a wide range of flow rates.

FEATURES AND BENEFITS

- » Single jet for severe installation conditions
- » Wide measuring range
- » Patented measuring chamber
- » Pre-equipped for communication

The Technology

Flodis has one of the simplest but highly engineered design, that enables to measure accurately over time from very low flow rates up to peak flows, even in severe environmental conditions when in service.

Reliability-Durability

- » Proven stable accuracy in tough installation conditions and high turbidity water. Flodis has been in service for our main customers for over 10 years now.
- » Millions of Flodis are currently in service around the world in many different climate conditions, always offering shortest return of investment over time.

- » The high quality of pivoting and levitation of the balanced turbine ensures exceptional endurance
- » The turbine is the only dynamic part in contact with water, offering the well-known durability of the product.
- » No need for adjustment due to its design and high technology implemented in manufacturing

Easy Reading

Flodis register combines the following advantages:

- » Rotation close to 360° on site
- » Large numbered rollers with good contrast for excellent reading capability
- » Wiper ensuring readability of the extra-dry register in tough humid conditions

- » The Copper Can register version assures water tightness in permanent immersion conditions

Communication Device

- » Pre-equipped for communication through Cyble.

Approvals and Standards

Flodis is certified from Q3 1,6 to 10 m³/h from Ratio 63 to 200 according with:

- » MID, Directive 2004/22/EC of the European Parliament
- » European Standard EN14154 - 2007
- » International Standard ISO 4064 - 2005
- » Recommendation OIML R49 - 2006

Flodis is also approved class C from 1.5 to 6 m³/h according with :

- » European Directive EEC 75/33 for cold potable water meters (expiring date October 2016).

Flodis is compliant with regulations for products to use in contact with water intended for human consumption.



Copper Can register for permanent immersion

WORKING PRINCIPLE

Flodis has two main components; the hydraulic that allows measurement of the water flow and the register that displays the measured water volume. Transmission interface between those components is achieved by a magnetic coupling **1**. Flodis is a single jet velocity meter. Flow coming from the inlet, diverted by a specially shaped injector **2** drives the turbine **3**. This technology is suitable for all types of distribution water quality.

Equipped with an upstream filter **4**, Flodis is protected against impurities accidentally conveyed by water. The magnetic coupling transmission, standard on the Flodis line, is accompanied by an extra-dry register. Both gears and register are in a waterproof and air proof enclosure. The turbine is the only moving part of the meter in motion in water.



Radio Frequency Cyble module fitted on Flodis meter

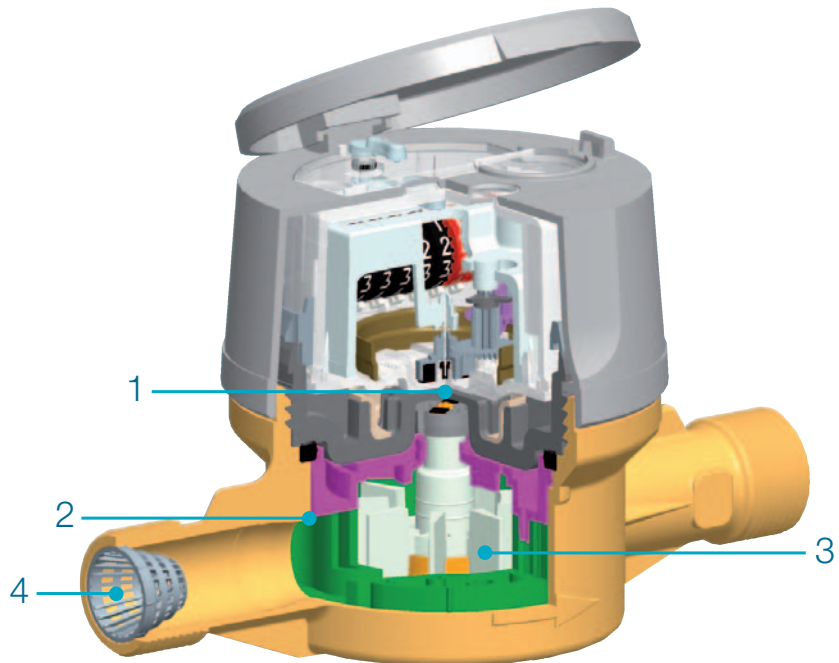

Radio Frequency Cyble module integrated in Flodis closure cap

COMMUNICATION

Flodis is supplied pre-equipped with Cyble Target Allows communication and remote reading through:

- » Pulse output (Cyble Sensor)
- » M-Bus protocol (Cyble M-Bus)
- » Radio frequency wireless link for mobile and fixed network (AnyQuest and EverBlu)

(please refer to specific leaflet)

Key Advantages of Cyble Technology

- » No need for additional investment on the meter to implement remote reading
- » Itron standardized meter interface, irrespective of meter technology and widely spread on Itron water meters range
- » Leakage detection
- » Reverse flow management
- » Consumption profile analysis
- » Immune to magnetic tampering
- » Principle proven on the field with a 20 years experience

Technical Specifications

Meter Capacity	mm	15	20	25	32
	inches	½"	¾"	1"	1" ¼

In compliance with MID - (2004/22/EC)

MID type Approval Number		LNE 19125	LNE 19864	LNE 14887	
Nominal Flow Rate (Q3)	m³/h	1.6	2.5	4	6.3
Standard Ratio Horizontal (*) (Q3/Q1)		100	160	160	160
Minimum Flow Rate (Q1)	l/h	16	15.6	25	39.4
Transitional Flow Rate (Q2)	l/h	25.6	25	40	63
Overload Flow Rate (Q4)	m³/h	2	3.1	5	7.9
Pressure Loss Class at Q3	bar	0.25	0.63	0.63	0.63
Maximum Admissible Pressure (MAP)	bar	16			
Sensitivity Class		UoDo			
Operating Temperature (T)	°C	0.1 / 50			
Climatic Environment	°C	5 / 55			

(*) Other Ratios available under specific request

In compliance with EEC 75/33

EEC metrology class	C horizontal - B all other positions				
EEC approval	F-06-G-1277				
Nominal flow rate Qn	m³/h	1.5	2.5	3.5	6
Maximum flow rate Qmax	m³/h	3	5	7	12
Minimum flow rate Qmin	l/h	15	25	35	60
Transitional flow rate Qt	l/h	22.5	37.5	52.5	90
Pressure loss group at Qmax	bar	< 1 (=0.8)			
Maximum admissible pressure	bar	16			
Maximum admissible temperature	°C	30			

Other Characteristics

Indication Range	99999,999				
Minimum Scale Interval	0.02				
Typical Starting Flow Rate	l/h	4	6	10	12
Testing Pressure	bar	25			
Communication pre-equipment	Cyble Technology				

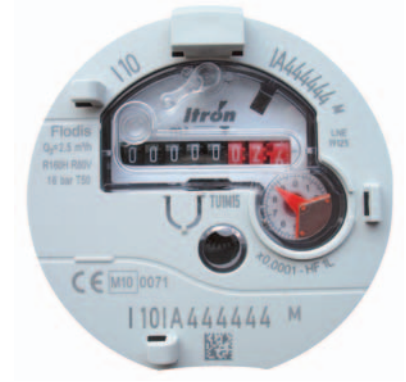

Flodis indicator MID marking

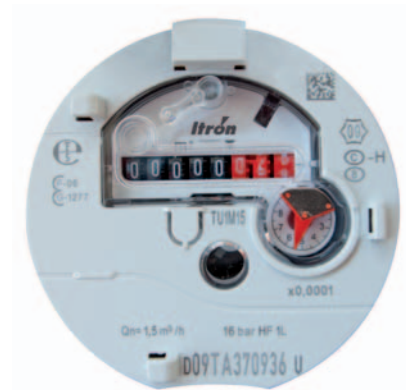

Flodis indicator EEC marking

TYPICAL ACCURACY CURVE, FLODIS RANGE

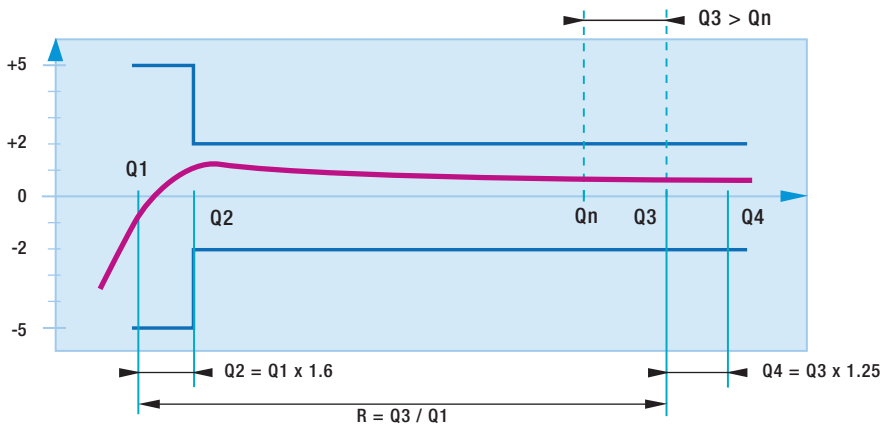

The dynamic range is defined as the Ratio (R) between the nominal and the minimum flowrate. The MID approval proves the Flodis real capacity to withstands to higher nominal flows ($Q3 > Qn$).



Flodis DN32

HEAD LOSS

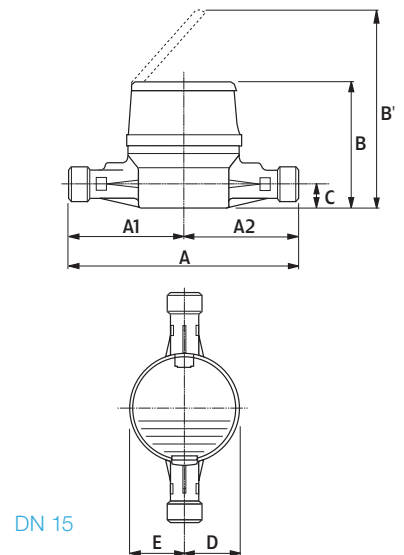
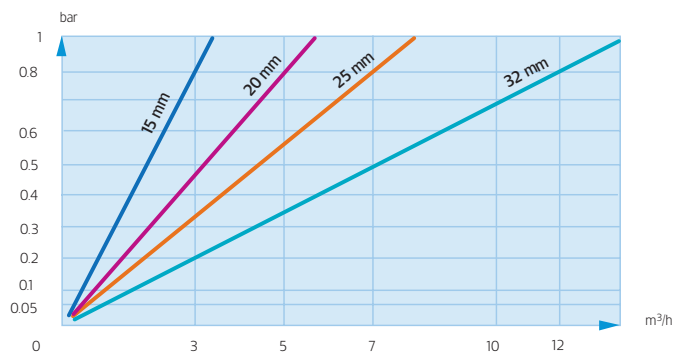

DN 15

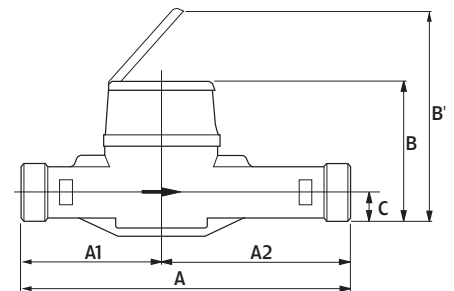

DN 20, 25 and 32

Dimensions and Weight

Nominal diameter (DN)	mm	15	20	25	32
Meter thread	inches	G 3/4"	G 1"	G 1 1/4"	G 1 1/2"
	mm	20 x 27	26 x 34	33 x 42	40 x 49
A	mm	110 - 170*	130 - 190	260	260
A1	mm	55 - 85	72 - 95	110	110
A2	mm	55 - 85	58 - 95	150	150
B	mm	104	123	130	130
B'	mm	183	203	210	210
C	mm	21.5	22.5	39	39
D	mm	46	64	64	67
E	mm	46	28	28	25
Weight Kg	Kg	0.75 - 0.9	0.85 - 1.1	2	2.2
F (additional height with module)	mm			42	

* Other available lengths 115, 145, 165 mm (G 3/4"), 115 mm (G 3/4" 7/8") and 165, 190 mm (G 1").

Pulse Value

Nominal diameter (DN)	HF Signal	LF Signal (according to K factor for Cyble Sensor Module)					
		K=1	K=2.5	K=10	K=25	K=100	K=1000
Meter range							
DN 15 to 32	1L	1L	2.5L	10L	25L	100L	1000L

OPTIONS (NON EXHAUSTIVE LIST)

Flodis meters may be fitted with:

- » Copper can register in case of installation in humid environment
- » Non return-valve for outlet pipe
- » Removable cap
- » Equipped with cyble modules from the factory

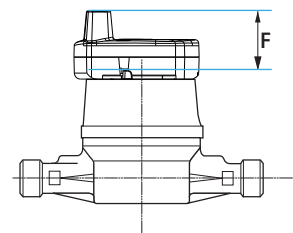

With Cyble module mounted



Our company is the world's leading provider of smart metering, data collection and utility software systems, with over 8,000 utilities worldwide relying on our technology to optimize the delivery and use of energy and water.

To realize your smarter energy and water future, start here: www.itron.com

For more information, contact your local sales representative or agency:

ITRON WATER METERING

9, rue Ampère
71031 Mâcon cedex
France

Phone: +33 3 85 29 39 00

Fax: +33 3 85 29 38 58